

Spacecraft Fire Experiment (*Saffire*) Development Status

Gary A. Ruff¹ and David L. Urban²
NASA Glenn Research Center, Cleveland, OH, USA

A. Carlos Fernandez-Pello³
UC Berkeley, Berkeley, CA, USA

James S. T'ien⁴
Case Western Reserve University, Cleveland, OH, USA

Jose L. Torero⁵
University of Queensland, Brisbane, Australia

Guillaume Legros⁶
Université Pierre et Marie Curie, Paris, France

Christian Eigenbrod⁷
University of Bremen (ZARM), Bremen, Germany

Nickolay Smirnov⁸
Moscow Lomonosov State University, Moscow, Russia

Osamu Fujita⁹
Hokkaido University, Sapporo, Japan

Adam J. Cowlard¹⁰
University of Edinburgh, Edinburgh, UK

Sebastien Rouvreau¹¹
Belisama R&D, Toulouse, France

Olivier Minster¹² and Balazs Toth¹³
ESA ESTEC, Noordwijk, Netherlands

Grunde Jomaas¹⁴
Technical University of Denmark, Kgs. Lyngby, Denmark

¹ Physical Scientist, Space Technology Office, 21000 Brookpark Road, MS 77-7, Associate Fellow

² Branch Chief, Combustion and Reacting Systems Branch, 21000 Brookpark Road, MS 77-5, Associate Fellow

³ Professor, Department of Mechanical Engineering, Etcheverry Hall, UC Berkeley, Berkeley, CA

⁴ Professor, Department of Mechanical Engineering, Glennan Bldg, Cleveland, OH

⁵ University of Queensland, Brisbane, Australia

⁶ Université Pierre et Marie Curie, Paris, France

⁷ University of Bremen (ZARM), Bremen, Germany

⁸ Moscow Lomonosov State University, Moscow, Russia

⁹ Hokkaido University, Sapporo, Japan

¹⁰ University of Edinburgh, Edinburgh, UK

¹¹ Belisama R&D, Toulouse, France

¹² ESA ESTEC, Noordwijk, Netherlands

¹³ ESA ESTEC, Noordwijk, Netherlands

¹⁴ Technical University of Denmark, Kgs. Lyngby, Denmark

The status is presented of a spacecraft fire safety research project that is under development to reduce the uncertainty and risk in the design of spacecraft fire safety systems for exploration missions. The Spacecraft Fire Safety Demonstration Project is developing three Spacecraft Fire Experiments (Saffire-I, -II, and -III) to conduct a series of material flammability tests at a length scale that is realistic for a serious spacecraft fire in low-gravity. The objectives of these experiments are to (1) determine how rapidly a large scale fire grows in low-gravity and (2) investigate the low-g flammability limits compared to those obtained in NASA's normal gravity material flammability screening test. The experiments will be conducted in Orbital Science Corporation's Cygnus vehicle after it has deorbited from the International Space Station. Although the experiment will need to meet rigorous safety requirements to ensure the carrier vehicle does not sustain damage, the absence of a crew removes the need for strict containment of combustion products. The tests will be fully automated with the data downlinked at the conclusion of the test before the Cygnus vehicle reenters the atmosphere. A computer modeling effort will complement the experimental effort. An international topical team is collaborating with the NASA team in the definition of experiment requirements and performing supporting analysis, experimentation and technology development. The status of the overall experiment are summarized in this paper along with a brief look at future experiments that could further enhance NASA's approach to spacecraft fire safety.

Nomenclature

AES	=	Advanced Exploration Systems
ATV	=	Automated Transfer Vehicle
ESA	=	European Space Agency
GRC	=	John. H. Glenn Research Center
HTV	=	H-II Transfer Vehicle
ISS	=	International Space Station
JAXA	=	Japan Aerospace Exploration Agency
OSC	=	Orbital Sciences Corporation
UPMC	=	Université Pierre et Marie Curie

I. Introduction

Tests on full-scale transportation vehicles, buildings, homes, and habitats have been common on earth to fully understand the associated fire hazards and how best to protect the passengers and inhabitants from a potential fire. Fire safety on spacecraft has been a significant concern for NASA during the decades of crewed spaceflight and will remain so as NASA plans its next phase of exploration missions. While combustion and fire processes have been one of the significant areas of research on the Space Shuttle and the International Space Station (ISS), there have been relatively few experiments directly studying spacecraft fire safety under low-gravity conditions. Furthermore, none of these experiments have studied sample and environment sizes typical of those expected in a spacecraft fire.¹ Prior experiments have been limited to samples no larger than 10 cm in length and width. Because of the large differences between fire behavior in normal and reduced gravity, there is a significant lack of data available for spacecraft designers on which to base their fire safety designs and procedures. The use of terrestrial fires and fire standards to design spacecraft fire safety systems presents an inherent risk to the vehicle because of the significant level of uncertainty. While this approach has been successful thus far, the uncertainty and risk will only increase as exploration missions venture further from earth with considerably longer transit times for a safe return. Despite their obvious importance, full scale spacecraft fire experiments have not been possible because of the inherent hazards involved in conducting a large fire test in a manned spacecraft. To address this knowledge gap, an experiment was proposed that will be conducted in an expendable spacecraft, enabling the fire safety experiment to be conducted without risk to crew or crewed spacecraft.

In October 2011, the NASA Advanced Exploration Systems program funded a project to develop and demonstrate spacecraft fire safety technologies in relevant environments. The stated keystone of these demonstrations was a large-scale fire safety experiment to be conducted on an International Space Station (ISS) resupply vehicle after it has undocked from the ISS and before it enters the atmosphere. The project team from NASA

John H. Glenn Research Center (GRC) was identified and began formulating this experiment. The NASA team was augmented by an international topical team assembled by the European Space Agency (ESA). Each member of this team (the authors of this article) brings expertise and funding from their respective space and research agencies for their activities. The participation of members from other countries and space agencies not only brings additional skills to the science team but also facilitates international cooperation in the development of an approach to spacecraft fire prevention and response for future exploration vehicles. No single experiment can address the range of issues that need to be resolved to fully understand the fire risk to future spacecraft and missions. The goal of the topical team is to leverage the international capabilities of each team member to develop a suite of ground-based and space flight spacecraft fire safety experiments that will expand the impact of the flight experiments. The current spaceflight experiment funded and being developed by NASA addresses two objectives. The first objective is to understand the flame spread and growth of a fire over an amount of flammable material consistent with what is likely to be in a spacecraft cabin. This sample material is approximately 1 meter long and 0.4 meters wide. This will be at least an order of magnitude larger than any prior low-g flame spread experiment. The second objective is to examine the flammability limits of materials in low gravity to determine if NASA's material selection methods are a reasonable predictor of low-gravity flammability. The status of the development of the flight experiment and the individual contributions of the topical team will be discussed in subsequent sections.

II. Background and Early Formulation

The unique objectives of this experiment necessitated the use of an expendable ISS resupply vehicle such as ESA's ATV, JAXA's HTV, Orbital Sciences Corporation's (Orbital's) *Cygnus* or SpaceX's *Dragon*. Early in the development of the project, the European Space Agency (ESA) became interested in this experiment. As a result, the ATV was the initial vehicle for which an experiment concept was developed. Dr. Olivier Minster, Senior Physical Scientist in the Directorate of Human Spaceflight for the European Space Agency formed an international topical team chaired by Professor Grunde Jomaas (Technical University of Denmark) and Professor Jose L. Torero (University of Queensland, Brisbane, Australia.). This Fire Safety in Space International Topical Team consists of 14 researchers from the European, Japanese, Russian, and U.S. spacecraft fire safety communities and is tasked to define research that would be possible from such a low-gravity fire safety experiment. The group developed the initial science and technology requirements for this experiment as well as ground-based experiments and modeling efforts that support this experimental campaign.

While many factors could go into the selection of a vehicle such as available volume, power availability, communication, *etc.*, the schedule and resources eventually became the most significant. With the planned ATV flights ending with ATV-5 in March 2014 (now moved to July 2014), it became unlikely that an experiment could be developed and integrated with the vehicle within that schedule. Since Orbital had planned eight *Cygnus* flights to begin in 2013 and extend through 2016, the use of the *Cygnus* vehicle was more promising for the successful completion of this experiment. Programmatic requirements and fire safety technology needs later drove the project to plan for three experiments to be performed on three consecutive flights of *Cygnus*. The first experiment would take place on the 5th *Cygnus* flight (Orb-5) currently planned for July 2015. Even though the ESA ATV-5 vehicle was no longer being considered for this experiment, the international topical team remained intact and functioning to help formulate the experiment and associated ground-based research.

III. Experiment Concept

The premise for the design of the flight experiment was that practically all of the hardware would be identical in the three units except possibly for the sample material(s) to be burned. The concept for this experiment focuses on conducting two types of material combustion tests to be performed on different flights of the *Cygnus* vehicle. The experiment package consists of a flow duct and an adjacent avionics bay. A schematic of the flow duct is shown in Fig. 1. The flow duct forms the primary chamber of the experiment while the avionics bay is connected to the side of the flow duct as shown in the figure. A LexanTM panel forms the wall between the flow duct and the avionics bay. Air is drawn through the flow duct by fans located at the top of the duct with flow straighteners at the bottom of the experiment module. The flow duct/avionics bay assembly is a rigid structure and will be secured with the standard stowage straps used in the *Cygnus* vehicle. This duct will provide a uniform flow across the samples, maintain a clear flow path within the experiment module, and prevent burning debris from interacting with the rest of the cargo. The experiment package is shown installed in the *Cygnus* vehicle in Fig. 2.

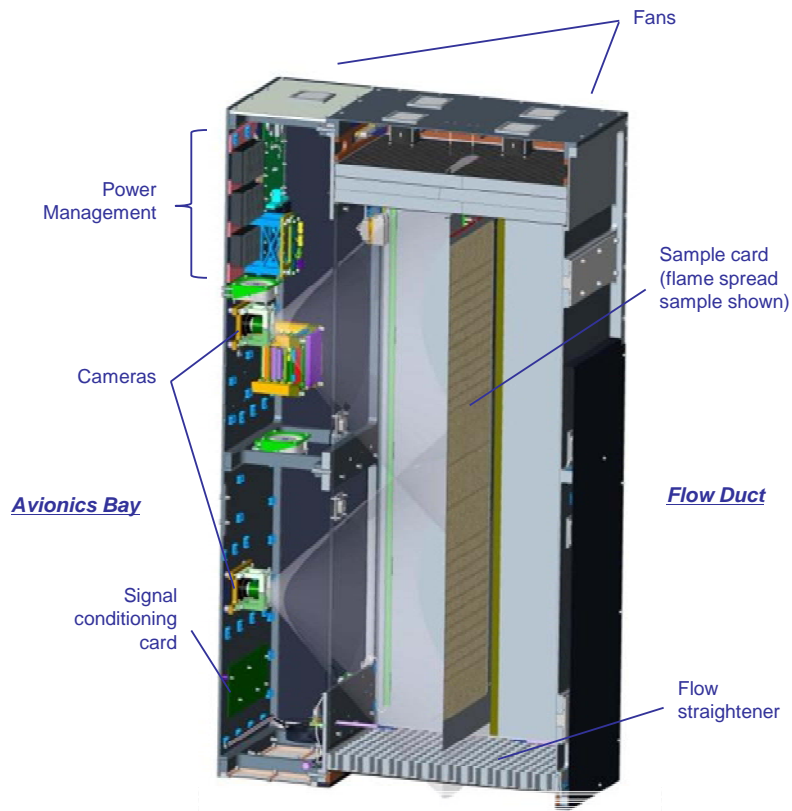

Figure 1: Schematic of the Spacecraft Fire Safety Demonstration Experiment.
The experiment module consists of a flow duct containing the sample card and an avionics bay. All power, computer, and data acquisition modules are contained in the bay. The experiment module is approximately 53- by 90- by 133-cm.

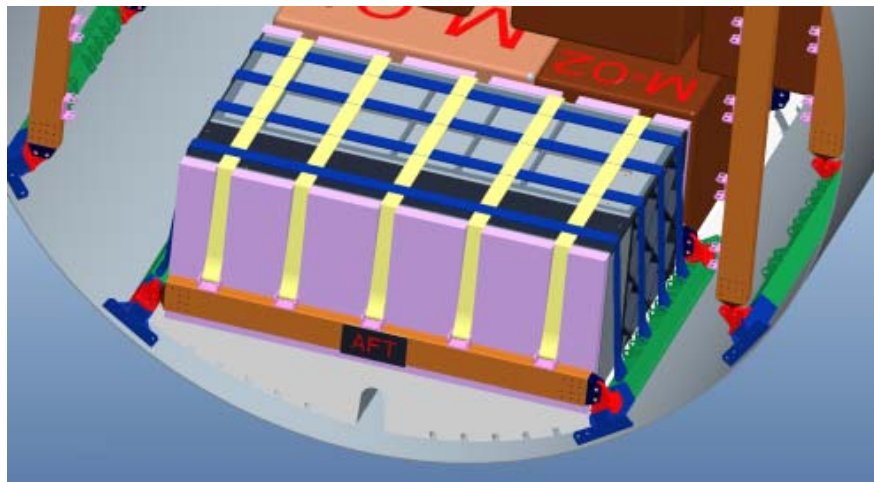

Figure 2: Experiment Module for the Spacecraft Fire Safety Demonstration shown installed in the Cygnus vehicle. *The other objects are standard cargo bags.*

The experiment package will have a range of diagnostics to monitor the test conditions. The ambient temperature will be measured at the inlet of the flow duct as well as upstream of the fans. The oxygen and CO₂ concentrations will be measured at the inlet of the avionics bay so that the sensors do not degrade the flow uniformity in the flow duct. A pressure transducer will also measure the pressure time-history. Flow anemometers will be placed at selected locations in the inlet flow, one on each side of the sample, to quantify the flow velocity in the duct and serve as input to the fan flow control algorithm. Two video cameras will provide front views of one side of the entire sample through a LexanTM panel separating the flow duct from the avionics bay. The sample will also be periodically illuminated by a green LED source to allow the measurement of the pyrolysis length. Four calibrated radiometers, two viewing the front and back of the sample, will measure the broadband radiative emission from the sample to provide an estimate of the radiative flux from the burning zone towards the surroundings. The flame stand-off distance is an important characteristic for comparing the data with computational models and will be measured for the larger flame spread samples using several thermocouples placed at varying heights above the sample surface. These will be woven into the sample and then bent so they are perpendicular to the surface.

The objective of the experiment in Saffire-I is investigate flame spread and growth in low-gravity to determine if there is a limiting flame size over a large surface and to quantify the size and growth rate of the flames. The flame will propagate over a panel of thin material approximately 0.4 m wide by 1.0 m long, shown in Fig. 1. The ignition method will be a hot wire woven into the fabric along the upstream edge. This material will be expected to burn at the anticipated cabin atmosphere. A second igniter will be woven into the fabric at the downstream end of the sample to serve as a backup. If the upstream igniter does not produce a propagating flame or does not propagate the entire length, the downstream igniter will provide a second opportunity to obtain flame spread data albeit for concurrent flame spread. The objective of the tests to be conducted on Saffire-II is to investigate the low-gravity Maximum Oxygen Concentration (MOC) flammability limits in long-term low gravity.² The configuration for these experiments consists of nine samples of varying materials (denoted flammability samples) each having dimensions of approximately 5 cm wide by 30 cm long installed on the same panel in place of the single sample in Fig. 1. These samples emulate the configuration used in NASA-STD-6001 Test 1.³ Each sample is ignited at the bottom using a hot wire. The oxygen concentration in the vehicle will be nearly 21% by volume—the same as in the ISS when the hatch was closed. The materials have been selected to be near their normal-gravity or hypothesized low-gravity maximum oxygen concentration in 21% O₂. This has complicated the selection of sample materials because most materials relevant for spacecraft do not have normal-gravity flammability limits near 21% oxygen by volume.⁴⁻⁶ Camera images are the primary diagnostics for these tests as the intended result is primarily to determine whether the flame propagates or self-extinguishes.

IV. Experiment Development Status

A. Design Status

The Mission Concept Review/System Requirements Review for the Spacecraft Fire Safety Demonstration Project was held in November 2012 (beginning of FY13). This review was to confirm the need for the experiment and demonstrate that the experiment as defined would obtain data to meet that need. The Review Board consisted not only of engineering and project management personnel but several people from NASA's spacecraft fire safety community serving as stakeholders. The science requirements contained in the Experiment Science Requirements Document (ESRD) were developed and translated into engineering requirements in the System Requirement Document (SRD). Following this review, the design of the hardware began in earnest and continued up to the Periodic Technical Review (PTR) – 1 that was held in June 2013. This review was a combined Preliminary Design Review/Critical Design Review (PDR/CDR) with the objective to baseline the experiment design. Typically for a CDR, all of the drawings are completed and the review signifies the approval to proceed to the fabrication phase of the project. Because of the tailoring (and pace) of the project, the project was at a PDR-level but only at approximately 80% CDR-level. In fact, fabrication of some of the smaller components had begun in May 2013, prior to the PDR/CDR. Both the incomplete CDR status and initiation of manufacturing introduced risk to the project but was deemed necessary to maintain the project schedule. The design was completed following PTR-1 and more of the components moved into fabrication.

B. Fabrication and Assembly Status

Saffire hardware consists of both mechanical and avionics fabrication processes and, since these functions are performed by different technicians, they present a variety of challenges to the project team. For example, because of the schedule imposed on the SFS Demo Project, fabrication of the mechanical components for three Saffire units

presented a staffing challenge to Manufacturing Shop at NASA-GRC. The Project decided that the fabrication of the first of the three hardware components was to be performed at NASA-GRC to ensure the accuracy of the drawings. After that, outside fab shops could be used to complete the fabrication operations. The drawings were divided into five drawing packages that were sequentially released for manufacturing. Instead of pursuing manufacturing at local fab shops, the project used the NASA Fabrication Alliance, a coordination of the fab shops at all NASA centers, to manufacture selected components of the Saffire hardware. The Fab Alliance performed much like a group of outside manufacturers with the NASA Centers bidding for fabrication of a set of released drawings. The SFS Demo Project awarded work to the Fabrication Shops at NASA Johnson Space Center (JSC) and White Sands Test Facility (WSTF). In general, these jobs proceeded well but some work was impacted by the partial government shutdown and Center re-organizations. Hardware from the Fab Alliance has all been received at NASA-GRC with any remaining fabrication to be completed at the Glenn Research Center. Avionics manufacturing was conducted entirely at NASA-GRC. One of the largest challenges has been having a sufficient number of avionics technicians certified to assemble three of each component of the flight hardware as required by the project schedule.

While manufacturing was coming to an end, preparations for assembly, integration, and test (AI&T) were being developed. Assembly procedures were being developed, personnel training was being performed, and process plans were being written. The project successfully completed PTR-2 in February 2014 which was a System Integration Review. This review is held when fabrication is complete and prior to the start of flight hardware assembly. In this case, instead of reviewing the actual hardware components, the Review Board assessed whether the Project had processes and procedures in place to initiate AI&T activities. As planned, readiness of individual hardware products, such as the data acquisition system, processor stack, power sub-system, cameras and light bars, *etc.* to be turned over to AI&T for assembly would be assessed in separate table-top reviews conducted by the Lead Systems Engineer and attended by Discipline Lead Engineers. These table-top reviews have begun and should be completed by June 2014. The AI&T process is continuing for the three flight units using products as they become available and/or pass their TTR. This will continue throughout the summer of 2014.

V. Science Development Status

The activities of the Science Team have focused on supporting the Engineering Team on activities such as camera characterization, radiometer characterization and calibration, and testing with the Ground Development Unit (GDU). Other activities have included the final selection of samples for the three Saffire flights and coordinating other research activities of the International Topical Team. These are discussed in the following sections.

A. Sample Selection

Given the small number of tests that are possible during the Saffire flight experiments, sample selection occupied a substantial portion of the effort of the Topical Team. Samples were selected to enable both of the main experiment objectives (1. flame growth and spread and 2. material flammability) to be addressed. The flights of Saffire-I and -III address objective 1 and will have a single sample of a cotton-fiberglass blend⁷ having an area density of 18.2 mg/cm². This is referred to as “SIBAL” fabric because it was originally developed for use by the Solid Inflammability Boundary at Low Speed experiment. This composite fabric consists of about 75% cotton and 25% inert fiberglass by weight. The thickness of the fuel sample is 0.3175 mm. This material has the advantage of maintaining its structural integrity even after the cotton has been consumed allowing the measurement of the char front and avoiding the tears and curling common with thin fuels. The samples on the two Saffire flights will be tested at different air flow rates (20 and 30 cm/s) with other conditions being identical. The samples will burn in concurrent mode with ignition across the entire leading edge. This configuration was selected because it is expected to produce the largest flame size.

In addition to the camera images of the Saffire-I and -III sample, six thermocouples will be sewn into the fabric to measure both the surface temperature and the temperature of the gas just off the surface. As shown in Fig. 3, the thermocouples will be positioned in two groups of three approximately 30 cm and 60 cm along the

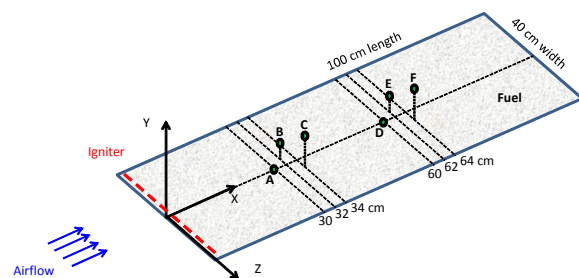

Figure 3: Flame and fuel surface temperature measurement locations for the large sample to be flown on Saffire-I and -III. Thermocouples B, C, E, and F are 1 cm off the centerline. Thermocouple B and C are 3 and 10 mm above the surface, respectively. Downstream thermocouple E is 8 mm above the surface while F is 25 mm.

longitudinal centerline of the sample. This will supply data that can be directly compared to computational simulations of the experiment.

The samples to be flown in Saffire-II will address material flammability. The sample size is selected to correspond to NASA STD 6001 Test 1³ and the sample holder accommodates 9 samples as shown in Fig 4. The test conditions are limited to nominally air at 1 bar so the challenge was to find samples where the flammability limit could be identified by other means. It was found by normal gravity testing that silicone membrane exhibits an upward flammability limit in air when the thickness is near 0.014". Three samples were selected: 0.010", 0.024", and 0.040". The thinnest sample burns readily in normal gravity while the thicker samples do not. The tests will identify whether there is any change in this behavior. Silicone has demonstrated the unusual behavior of burning in a downward (opposed) configuration for conditions where it will not burn upward (concurrent). Another 0.014" silicone sample will be burned in opposed configuration to see if this behavior is seen in low-gravity. This contrary behavior would violate the underpinning of NASA Test 1 which assumes that upward flame spread is the worst case. Two more samples (SIBAL) will be of the same material used in the Saffire-I and -III flights. The flow conditions will duplicate those of the large samples so that scaling issues can be examined. The flammability of thick materials will be studied through two 10 mm thick polymethyl methacrylate (PMMA) samples. Both of these will burn in concurrent mode with flames on both sides of the sample. One piece will be flat and the other will have lengthwise grooves of different edge radii to examine edge effects as shown in Fig. 5. The design of the sample was proposed by the researchers from the University of Bremen and will investigate the impact of surface structure on the flame propagation and flammability limits. Finally, one sample will be NomexTM which is a flame resistant material that is used commonly as a fire stop on spacecraft. This sample is not expected to burn even though a short segment of PMMA will be at the leading edge to promote ignition.

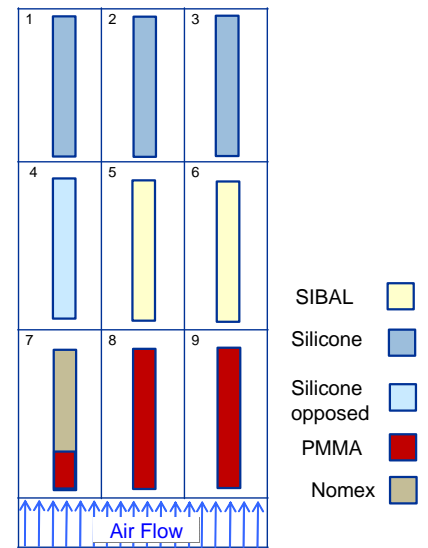

Figure 4: Sample layout for Saffire-II

Thermocouples will also be installed on the two SIBAL samples on Saffire-II for comparison with the surface and gas temperature measurements on the large Saffire-I and -III samples. The locations of these thermocouples are shown in Fig. 6. Thermocouples will also be placed on the NomexTM sample at locations shown in Fig. 7.

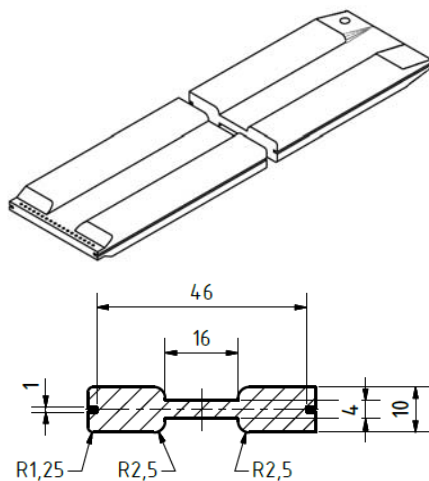

Figure 5: Structured PMMA sample. (a) Sample configuration. The design for this sample was provided by researchers from the University of Bremen. The sample is 300 mm long and 50 mm wide. (b) Sample cross section. All dimensions are in mm.

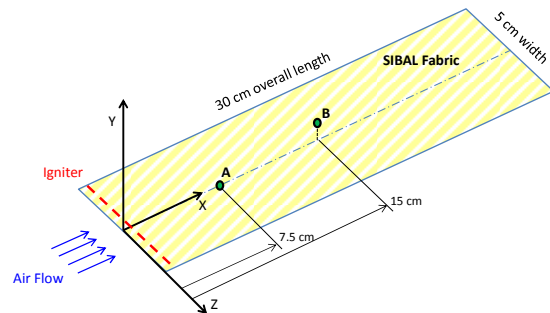

Figure 6: Thermocouple locations on the SIBAL fabric samples on Saffire-II. Thermocouple A is on the surface and thermocouple B is 5 mm above the surface.

VI. Future Experiments

The experiments being developed for Saffire-I, -II, and -III will be the first of their kind to evaluate low-g material flammability with direct implications for fire safety on future exploration vehicles. One of the drawbacks of these experiments is that a relatively small number of tests will be conducted (two large samples and nine small samples). A thorough evaluation of these phenomena would require many more samples and materials. Also, if they are typical of most low-g combustion experiments, the findings will raise additional significant questions for material flammability in spacecraft. The Saffire hardware and the Cygnus vehicle provide a unique opportunity to demonstrate other fire safety technologies including fire detection, fire suppression, post-fire cleanup and monitoring. These follow-on experiments to the first Saffire flights could address questions such as how much fire suppressant is required to extinguish a plausible spacecraft fire, or how much sorbent material is required to clean up a habitable volume in a specified period of time following a fire? These questions and the associated technologies are being evaluated by NASA fire safety stakeholders to formulate up to three additional flights on Cygnus (Saffire-IV, -V, and -VI). The results of this formulation will under a Mission Concept Review and be presented to the Advanced Exploration Systems for approval of funding prior to proceeding with experiment development. Of course, any future experiments would draw heavily on the Saffire design described herein to reduce the cost and time required for experiment development.

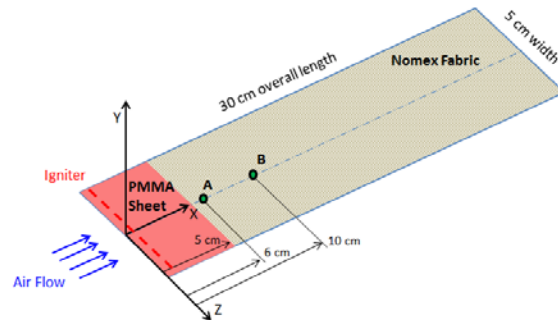

Figure 7: Thermocouple locations on the PMMA/Nomex™ sample on Saffire-II. Both the A and B thermocouples are mounted on the surface.

VII. Conclusion

Predicting the end state of an unconstrained fire in a spacecraft and validating NASA's flammability test methods are probably the areas of greatest uncertainty in our effort to ensure the fire safety of future spacecraft. These questions are being addressed by the Spacecraft Fire Safety Demonstration Project that is developing the Saffire hardware to conduct material flammability experiments on Orbital's *Cygnus* vehicle after it has deorbited from the ISS and before it reenters the atmosphere. This provides a habitable pressurized environment of considerable size without the hazards associated with a crewed vehicle. This opportunity enables the study of practical low-g material flammability phenomena that are important for spacecraft design yet cannot be studied in ISS facilities or other orbital platforms. The Saffire experiment has progressed through the design phase, most of the fabrication phase and is being assembled as components are completed. This experiment will be a landmark for spacecraft fire safety with the data and subsequent analysis providing much needed verifications of spacecraft fire safety protocol for the crews of future exploration vehicles and habitats. Experiment content for follow-on flights that addresses other questions and needs in spacecraft fire safety are being developed.

Acknowledgments

The authors acknowledge the support of the various space and research agencies that have supported this work including but not limited to: JAXA, ESA, RSA, the Centre National d'Etudes Spatiales, and the NASA Advanced Exploration Systems Program.

REFERENCES

1. Ruff, G.A., Urban, D.L., Pedley, M.D., Johnson, P.T., Safety Design for Space Systems edited by Gary Musgrave et al. Chapter 27 "Fire Safety," Elsevier, 2009.
2. Hirsch, D.B., Williams, J.H., Haas, J.P., Beeson, H.D., and Pedley, M.D., "Oxygen Concentration Flammability Thresholds of Selected Aerospace Materials Considered for the Constellation Program," Proceedings of the 2nd IAASS Conference, Chicago, May 14-16, 2007; (also ESA SP-645, July 2007).

3. National Aeronautics and Space Administration Technical Standard 6001.A, "Flammability, Odor, Offgasing and Compatibility Requirements and Test Procedures for Materials in Environments That Support Combustion," 2008.
4. Hirsch, D.B., Williams, J.H., Harper, S.A., Beeson, H.D., Ruff, G.A., and Pedley, M.D., "Pressure Effects on the Self-Extinguishment Limits of Aerospace Materials," Paper No. 2009-01-2490, 39th International Conference on Environmental Systems, Savannah, GA, July 12-16, 2009.
5. Olson, S.L., Ruff, G.A., Miller, F.J., "Microgravity Flame Spread in Exploration Atmospheres: Pressure, Oxygen, and Velocity Effects on Opposed and Concurrent Flame Spread," Paper No. 2008-01-2005, 38th International Conference on Environmental Systems, San Francisco, CA, June 29-July 2, 2008.
6. Olson, S.L., Hirsch, D.B., and Ferkul, P.V., "Improving Materials Flammability Screening For Spacecraft Fire Safety," Proceedings of the 2010 Technical Meeting of the Central States Section of the Combustion Institute, Champaign, Illinois, March 2010.
7. Xiaoyang Zhao and James S. T'ien, "A Three-dimensional Transient Model for Flame Growth and Extinction in Concurrent Flows", Spring Technical Meeting of the Central States Section of the Combustion Institute Mar 16-18, 2014.